

Tungaloy

Member IMC Group

Keeping the Customer First

Tungaloy Report No. 381-E

MILLLINE Indexable end mills

TUNGMEISTER



New End milling Innovation!!



The most effective tooling solution with the option of hundreds of tools!

Tool changeover times can be measurably reduced!

Features

► **Reduces tool changeover times drastically!!**

- Machine downtime is decreased considerably.
- Enables users to only change cutting head, simplifying set-ups.

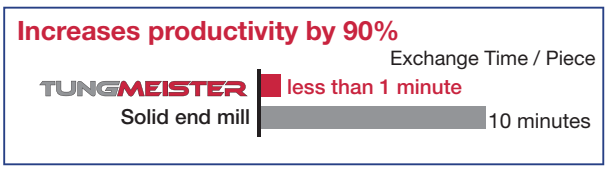

► **Highly accurate repeatability**

- Accuracy can be maintained by touching the taper and face.
- Repeatability is guaranteed and is not a concern for machine operators.

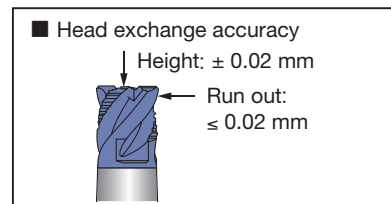
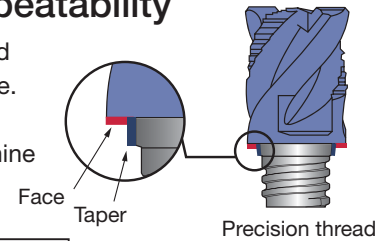

► **The weight of the tool to be disposed is reduced**

- Reduces tool disposal

For example: $\varnothing 12$ mm / square end mill

TUNGMEISTER: OAL 20 mm \rightarrow weight 20 g
conventional solid end mill: OAL 80 mm \rightarrow weight 140 g

► **No regrinding cost**

- No laborious end mill regrinding required.
- Easily replaceable heads eliminate the use of worn cutting edges.
- All tools can be used to breakage point or maximum wear point as no regrinding is necessary.

1 Wide range of cutting heads

23 kinds of cutting heads are available. The head exchange is easy and highly accurate with the precision thread.

Flexible combinations
TungMeister can be applied to all kinds of end mill machining applications.

2 Three kinds of shank material

Users can choose the most suitable combination according to the machining parameters, length and rigidity required.







Overview

● Head

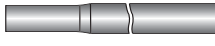
Head	Square	Ball	Toroidal	Drilling (Centering drill)	Chamfering	Grooving
Appearance						
Page	P. 4 ~ 7	P. 8 ~ 9	P.10 ~ 11	P. 11 ~ 12	P. 13	P. 14 ~ 16

● Shank

Shank	Straight	Weldon	Straight	Straight	Adaptor for TungFlex
Neck	Straight	Straight	Taper	(Grooving)	
Appearance					
Steel	●	●	●	●	●
Carbide	●	-	●	●	-
Tungsten (with oil hole)	●	-	●	-	-
Page	P. 17, 18	P. 17	P. 19	P. 20	P. 20

Cutting performance

Work material: SUS304 (200HB)	Grade: AH725	Machine : Horizontal M/C BT40
Head : VEE100L07.0R05-04S06 (ø10 mm, square type, 4 flutes)	Shank: VSSD10L075S06-S (Straight shank & neck, steel)	Holder : Collet chuck Cutting fluids: Dry

Comparison of milling for stainless steels

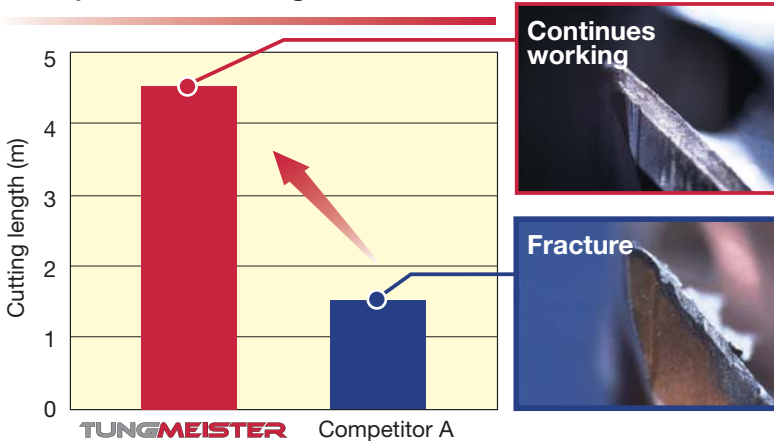

Cutting speed: $V_c = 100$ m/min
 Feed rate : $f_z = 0.07$ mm/t
 Depth of cut : $a_p = 5$ mm
 Cutting width : $a_e = 1.5$ mm

- Competitor A cutting edges fractured after 1.7 minutes machining and 1.5 m cutting length.
- The TungMeister cutting edges maintain operation after 5 minutes machining.

Comparison of milling surface on stainless steels



Cutting speed: $V_c = 130$ m/min
 Feed rate : $f_z = 0.05$ mm/t
 Depth of cut : $a_p = 5$ mm
 Cutting width : $a_e = 2$ mm

- When machining tough stainless steel the burr with the TungMeister is minimal. However, competitor A has a large burr when working under the same conditions.

Heads - Specification

● **Square**

VEE type 3 flutes, 45° helix (for general purpose)

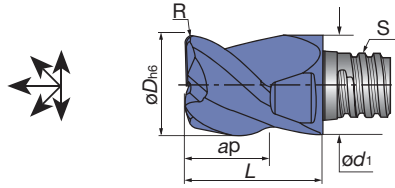

ap = Max. depth of cut
S = Connection screw size

Cat. No.	Grade AH725	No. of flutes	Helix angle	Dimensions (mm)						Wrench	Torque (N·m)
				øD	ød1	ap	R	S	L		
VEE080L05.0R00-03S05	●	3	45°	8	7.7	5	0	S05	10.0	KEYV-S05	7
VEE100L07.0R00-03S06	●	3	45°	10	9.7	7	0	S06	13.0	KEYV-S06	10
VEE120L09.0R00-03S08	●	3	45°	12	11.7	9	0	S08	16.5	KEYV-S08	15

VED / VEE type 4 flutes, 30° & 45° helix (for general purpose, corner radii: 0 ~ 4.0 mm)

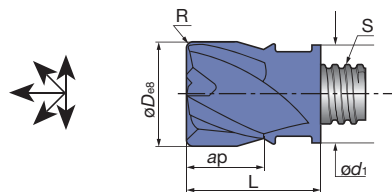

ap = Max. depth of cut
S = Connection screw size

Cat. No.	Grade AH725	No. of flutes	Helix angle	Dimensions (mm)						Wrench	Torque (N·m)
				øD	ød1	ap	R	S	L		
VEE060L05.0R00-04S05	●	4	45°	6	8	5	0	S05	10.0	KEYV-S05	7
VEE080L05.0R00-04S05	●	4	45°	8	7.7	5	0	S05	10.0		
VED080L05.0R05-04S05	●	4	30°	8	7.7	5	0.5	S05	10.0		
VED080L05.0R10-04S05	●	4	30°	8	7.7	5	1.0	S05	10.0		
VED080L05.0R15-04S05	●	4	30°	8	7.7	5	1.5	S05	10.0		
VEE100L07.0R00-04S06	●	4	45°	10	9.7	7	0	S06	13.0	KEYV-S06	10
VED100L07.0R05-04S06	●	4	30°	10	9.7	7	0.5	S06	13.0		
VEE100L07.0R05-04S06	●	4	45°	10	9.7	7	0.5	S06	13.0		
VED100L07.0R10-04S06	●	4	30°	10	9.7	7	1.0	S06	13.0		
VED100L07.0R10-04S06	●	4	45°	10	9.7	7	1.0	S06	13.0		
VEE120L09.0R00-04S08	●	4	45°	12	11.7	9	0	S08	16.5	KEYV-S08	15
VED120L09.0R05-04S08	●	4	30°	12	11.7	9	0.5	S08	16.5		
VEE120L09.0R05-04S08	●	4	45°	12	11.7	9	0.5	S08	16.5		
VED120L09.0R10-04S08	●	4	30°	12	11.7	9	1.0	S08	16.5		
VED120L09.0R10-04S08	●	4	45°	12	11.7	9	1.0	S08	16.5		
VEE160L12.0R00-04S10	●	4	45°	16	15.3	12	0	S10	20.5	KEYV-S10	28
VED160L12.0R05-04S10	●	4	30°	16	15.3	12	0.5	S10	20.5		
VEE160L12.0R05-04S10	●	4	45°	16	15.3	12	0.5	S10	20.5		
VED160L12.0R10-04S10	●	4	30°	16	15.3	12	1.0	S10	20.5		
VEE160L12.0R10-04S10	●	4	45°	16	15.3	12	1.0	S10	20.5		
VED160L12.0R15-04S10	●	4	30°	16	15.3	12	1.5	S10	20.5		
VEE160L12.0R15-04S10	●	4	45°	16	15.3	12	1.5	S10	20.5		
VED160L12.0R20-04S10	●	4	30°	16	15.3	12	2.0	S10	20.5		
VEE160L12.0R20-04S10	●	4	45°	16	15.3	12	2.0	S10	20.5		
VED160L12.0R30-04S10	●	4	30°	16	15.3	12	3.0	S10	20.5		
VEE160L12.0R30-04S10	●	4	45°	16	15.3	12	3.0	S10	20.5		
VED160L12.0R40-04S10	●	4	30°	16	15.3	12	4.0	S10	20.5	KEYV-S12	28
VEE160L12.0R40-04S10	●	4	45°	16	15.3	12	4.0	S10	20.5		
VEE200L15.0R00-04S12	●	4	45°	20	18.3	15	0	S12	25.5		
VED200L15.0R05-04S12	●	4	30°	20	18.3	15	0.5	S12	25.5		
VED200L15.0R10-04S12	●	4	30°	20	18.3	15	1.0	S12	25.5		
VED200L15.0R20-04S12	●	4	30°	20	18.3	15	2.0	S12	25.5		
VED200L15.0R30-04S12	●	4	30°	20	18.3	15	3.0	S12	25.5		

● : Stocked items
Packing Quantity = 2 pcs.

Square

VEE / VED type 6 flutes, 30°, 45° & 50° helix (without central edge, corner radii: 0 ~ 1.5 mm)

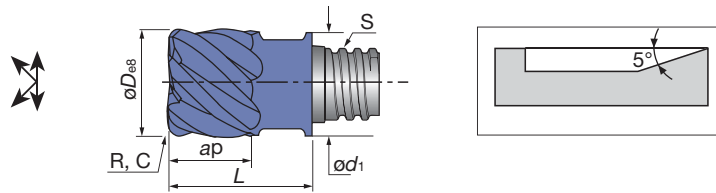

a_p = Max. depth of cut
 S = Connection screw size

Cat. No.	Grades		No. of flutes	Helix angle	Dimensions (mm)							Wrench	Torque (N·m)
	AH725	AH750			$\varnothing D$	$\varnothing d_1$	a_p	R	C	S	L		
VEE080L05.0R05-06S05	●		6	45°	8	7.7	5	0.5	-	S05	10.0	KEYV-S05	7
VEE080L05.0R10-06S05	●		6	45°	8	7.7	5	1.0	-	S05	10.0		
VEE080L05.0R15-06S05	●		6	45°	8	7.7	5	1.5	-	S05	10.0		
VEE080L05.0C10-06S05		●	6	50°	8	7.7	5	-	0.1	S05	10.0		
VEE100L07.0R00-06S06	●		6	45°	10	9.7	7	0	-	S06	13.0	KEYV-S06	10
VED100L07.0R05-06S06	●		6	30°	10	9.7	7	0.5	-	S06	13.0		
VEE100L07.0R05-06S06	●		6	45°	10	9.7	7	0.5	-	S06	13.0		
VED100L07.0R10-06S06	●		6	30°	10	9.7	7	1.0	-	S06	13.0		
VEE100L07.0R10-06S06	●		6	45°	10	9.7	7	1.0	-	S06	13.0		
VED100L07.0R15-06S06	●		6	30°	10	9.7	7	1.5	-	S06	13.0		
VEE100L07.0R15-06S06	●		6	45°	10	9.7	7	1.5	-	S06	13.0		
VEE100L07.0C10-06S06		●	6	50°	10	9.7	7	-	0.1	S06	13.0		
VEE120L09.0R00-06S08	●		6	45°	12	11.7	9	0	-	S08	16.5	KEYV-S08	15
VED120L09.0R05-06S08	●		6	30°	12	11.7	9	0.5	-	S08	16.5		
VED120L09.0R10-06S08	●		6	30°	12	11.7	9	1.0	-	S08	16.5		
VEE120L09.0R10-06S08	●		6	45°	12	11.7	9	1.0	-	S08	16.5		
VEE120L09.0R15-06S08	●		6	45°	12	11.7	9	1.5	-	S08	16.5		
VEE120L09.0C10-06S08		●	6	50°	12	11.7	9	-	0.1	S08	16.5		

● For hardened and difficult-to-cut materials

VEE / VED type 8 / 10 flutes, 30° & 50° helix (without central edge, corner radii: 0.5 ~ 2.0 mm)

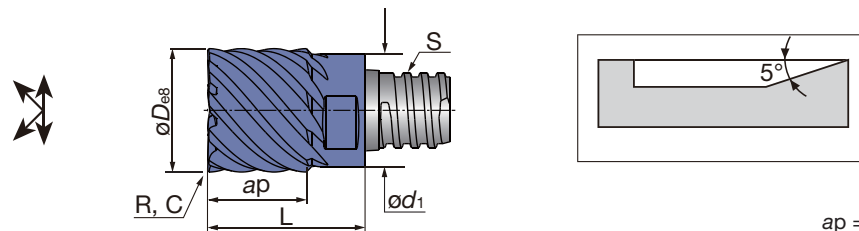

a_p = Max. depth of cut
 S = Connection screw size

Cat. No.	Grades		No. of flutes	Helix angle	Dimensions (mm)							Wrench	Torque (N·m)
	AH725	AH750			$\varnothing D$	$\varnothing d_1$	a_p	R	C	S	L		
VED160L12.0R05-08S10	●		8	30°	16	15.3	12	0.5	-	S10	20.5	KEYV-S10	28
VED160L12.0R10-08S10	●		8	30°	16	15.3	12	1.0	-	S10	20.5		
VED160L12.0R16-08S10	●		8	30°	16	15.3	12	1.6	-	S10	20.5		
VED160L12.0R20-08S10	●		8	30°	16	15.3	12	2.0	-	S10	20.5		
VEE160L12.0C20-08S10		●	8	50°	16	15.3	12	-	0.2	S10	20.5		
VED200L15.0R10-10S12	●		10	30°	20	18.3	15	1.0	-	S12	25.5	KEYV-S12	28
VED200L15.0R20-10S12	●		10	30°	20	18.3	15	2.0	-	S12	25.5		
VEE200L15.0C20-10S12		●	10	50°	20	18.3	15	-	0.2	S12	25.5		

● For hardened and difficult-to-cut materials

● : Stocked items
Packing Quantity = 2 pcs.

● **Square**

VEE type

3 flutes, 38° helix, for roughing before keyways (corner radii: 0.2 ~ 0.4 mm)

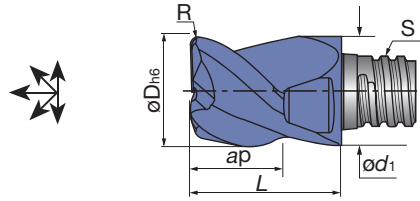

ap = Max. depth of cut
S = Connection screw size

Cat. No.	Grade AH725	No. of flutes	Helix angle	Dimensions (mm)						Wrench	Torque (N·m)
				øD	ød1	ap	R	S	L		
VEE077L04.0R02-03S05	●	3	38°	7.7	7.7	4	0.2	S05	10.0	KEYV-S05	7
VEE097L05.0R03-03S06	●	3	38°	9.7	9.7	5	0.3	S06	13.0	KEYV-S06	10
VEE117L07.0R03-03S08	●	3	38°	11.7	11.7	7	0.3	S08	16.5	KEYV-S08	15
VEE157L08.0R03-03S10	●	3	38°	15.7	15.3	8	0.3	S10	20.5	KEYV-S10	28
VEE197L12.0R04-03S12	●	3	38°	19.7	18.3	12	0.4	S12	25.5	KEYV-S12	28

VEE-A type

2 flutes, 45° helix, for aluminium machining (corner radii: 0.5 ~ 1.0 mm)

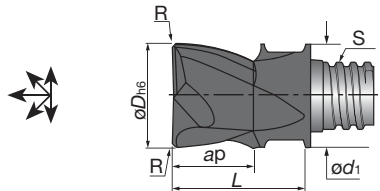

ap = Max. depth of cut
S = Connection screw size

Cat. No.	Grade KS15F	No. of flutes	Helix angle	Dimensions (mm)						Wrench	Torque (N·m)
				øD	ød1	ap	R	S	L		
VEE100L07.0R05A02S06	●	2	45°	10	9.7	7	0.5	S06	13.0	KEYV-S06	10
VEE100L07.0R10A02S06	●	2	45°	10	9.7	7	1.0	S06	13.0		
VEE120L09.0R05A02S08	●	2	45°	12	11.7	9	0.5	S08	16.5	KEYV-S08	15

● For non-ferrous metals, polished surface

VEE-A type

3 flutes, 45° helix, for aluminium machining (corner radii: 0 ~ 2.0 mm)

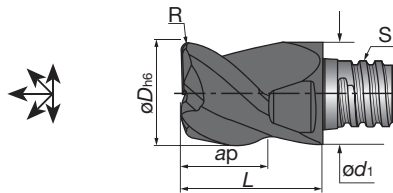

ap = Max. depth of cut
S = Connection screw size

Cat. No.	Grade KS15F	No. of flutes	Helix angle	Dimensions (mm)						Wrench	Torque (N·m)
				øD	ød1	ap	R	S	L		
VEE080L05.0R05A03S05	●	3	45°	8	7.7	5	0.5	S05	10.0	KEYV-S05	7
VEE100L06.0R05A03S06	●	3	45°	10	9.7	6	0.5	S06	13.0	KEYV-S06	10
VEE100L06.0R10A03S06	●	3	45°	10	9.7	6	1.0	S06	13.0		
VEE120L08.0R05A03S08	●	3	45°	12	11.7	8	0.5	S08	16.5	KEYV-S08	15
VEE120L08.0R10A03S08	●	3	45°	12	11.7	8	1.0	S08	16.5		
VEE160L10.0R00A03S10	●	3	45°	16	15.3	10	0	S10	20.5	KEYV-S10	28
VEE160L10.0R10A03S10	●	3	45°	16	15.3	10	1.0	S10	20.5		
VEE160L10.0R20A03S10	●	3	45°	16	15.3	10	2.0	S10	20.5		
VEE200L12.0R05A03S12	●	3	45°	20	18.3	12	0.5	S12	25.5	KEYV-S12	28
VEE200L12.0R10A03S12	●	3	45°	20	18.3	12	1.0	S12	25.5		
VEE200L12.0R20A03S12	●	3	45°	20	18.3	12	2.0	S12	25.5		

● For non-ferrous metals, polished surface

● : Stocked items
Packing Quantity = 2 pcs.

Square

VEE-I type

4 flutes, 38° helix, irregular-pitch flutes (chatter free)

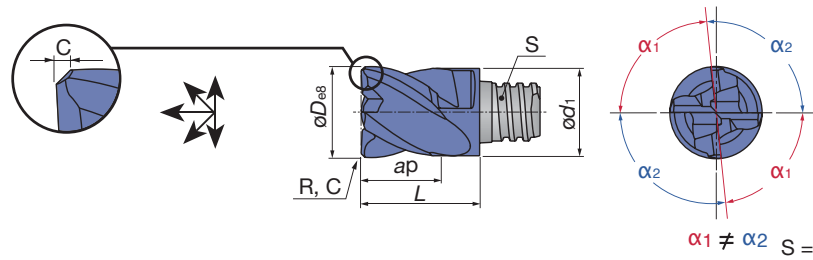

ap = Max. depth of cut
 S = Connection screw size
 $\alpha_1 \neq \alpha_2$

Cat. No.	Grade AH725	No. of flutes	Helix angle	Dimensions (mm)						Wrench	Torque (N·m)
				$\varnothing D$	$\varnothing d_1$	ap	C	S	L		
VEE080L05.0C30I04S05	●	4	38°	8	7.7	5	0.3	S05	10.0	KEYV-S05	7
VEE100L07.0C40I04S06	●	4	38°	10	9.7	7	0.4	S06	13.0	KEYV-S06	10
VEE120L09.0C50I04S08	●	4	38°	12	11.7	9	0.5	S08	16.5	KEYV-S08	15
VEE160L12.0C60I04S10	●	4	38°	16	15.3	12	0.6	S10	20.5	KEYV-S10	28
VEE200L15.0C60I04S12	●	4	38°	20	18.3	15	0.6	S12	25.5	KEYV-S12	28

● Head of chamfered corner

VEE-R type

4 / 5 / 6 flutes, 45° helix, for roughing

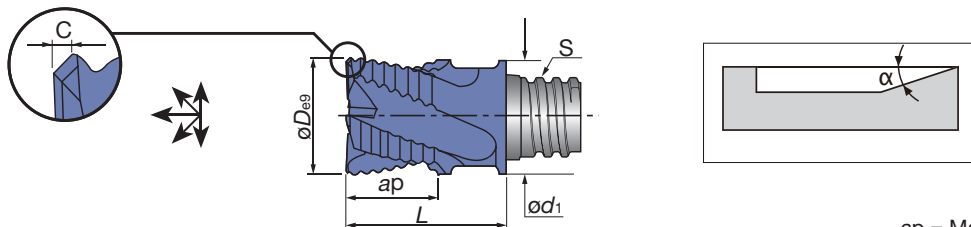

ap = Max. depth of cut
 S = Connection screw size

Cat. No.	Grade AH725	No. of flutes	Helix angle	Dimensions (mm)							Wrench	Torque (N·m)
				$\varnothing D$	$\varnothing d_1$	ap	C	S	L	α		
VEE080L05.0C25R04S05	●	4	45°	8	7.7	5	0.25	S05	10.0	90°	KEYV-S05	7
VEE100L07.0C30R04S06	●	4	45°	10	9.7	7	0.3	S06	13.0	90°	KEYV-S06	10
VEE120L09.0C35R04S08	●	4	45°	12	11.7	9	0.35	S08	16.5	90°	KEYV-S08	15
VEE160L12.0C40R05S10	●	5	45°	16	15.3	12	0.4	S10	20.5	7°	KEYV-S10	28
VEE200L15.0C40R06S12	●	6	45°	20	18.3	15	0.4	S12	25.5	3°	KEYV-S12	28

VEE-C type

4 flutes, 45° helix (combined edges for finishing & roughing)

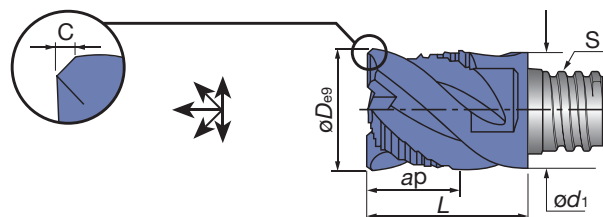

ap = Max. depth of cut
 S = Connection screw size

Cat. No.	Grade AH725	No. of flutes	Helix angle	Dimensions (mm)						Wrench	Torque (N·m)
				$\varnothing D$	$\varnothing d_1$	ap	C	S	L		
VEE080L05.0C30C04S05	●	4	45°	8	7.7	5	0.3	S05	10.0	KEYV-S05	7
VEE100L07.0C30C04S06	●	4	45°	10	9.7	7	0.3	S06	13.0	KEYV-S06	10
VEE120L09.0C40C04S08	●	4	45°	12	11.7	9	0.4	S08	16.5	KEYV-S08	15
VEE160L12.0C60C04S10	●	4	45°	16	15.3	12	0.6	S10	20.5	KEYV-S10	28
VEE200L15.0C60C04S12	●	4	45°	20	18.3	15	0.6	S12	25.5	KEYV-S12	28

● : Stocked items
Packing Quantity = 2 pcs.

● **Ball**

VBB-BM type 2 flutes, 0° helix (for general purpose)

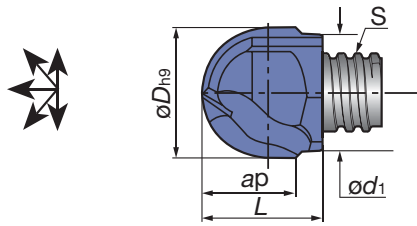

ap = Max. depth of cut
S = Connection screw size

Cat. No.	Grade AH725	No. of flutes	Helix angle	Dimensions (mm)					Wrench	Torque (N·m)
				øD	ød1	ap	S	L		
VBB080L08.0-BM-02S05	●	2	0°	8	7.6	8	S05	10.0	KEYV-S05	7
VBB100L10.0-BM-02S06	●	2	0°	10	9.5	10	S06	12.4	KEYV-S06	10
VBB120L12.0-BM-02S08	●	2	0°	12	11.5	11.5	S08	15.3	KEYV-S08	15
VBB160L16.0-BM-02S10	●	2	0°	16	15.2	16	S10	19.1	KEYV-S10	28

● For roughing

VBB-BG type 2 flutes, 0° helix (for high precision)

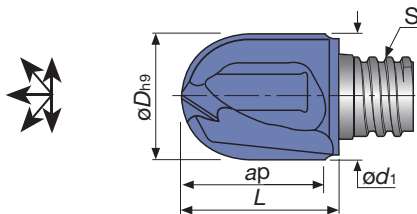

ap = Max. depth of cut
S = Connection screw size

Cat. No.	Grade AH750	No. of flutes	Helix angle	Dimensions (mm)					Wrench	Torque (N·m)
				øD	ød1	ap	S	L		
VBB080L08.0-BG-02S05	●	2	0°	8	7.6	8	S05	10.0	KEYV-S05	7
VBB100L10.0-BG-02S06	●	2	0°	10	9.6	10	S06	12.4	KEYV-S06	10
VBB120L12.0-BG-02S08	●	2	0°	12	11.5	12	S08	15.3	KEYV-S08	15
VBB160L16.0-BG-02S10	●	2	0°	16	15.2	16	S10	19.1	KEYV-S10	28

VBD-BG type 2 flutes, 30° helix (for high precision)

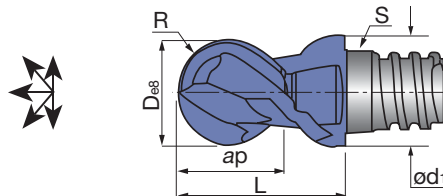

ap = Max. depth of cut
S = Connection screw size

Cat. No.	Grade AH725	No. of flutes	Helix angle	Dimensions (mm)						Wrench	Torque (N·m)
				øD	ød1	ap	R	S	L		
VBD080L05.0-BG-02S05	●	2	30°	8	7.7	5	3.982 ⁽¹⁾	S05	10.0	KEYV-S05	7
VBD100L07.0-BG-02S06	●	2	30°	10	9.7	7	4.982 ⁽¹⁾	S06	13.0	KEYV-S06	10
VBD120L09.0-BG-02S08	●	2	30°	12	11.7	9	5.978 ⁽²⁾	S08	16.5	KEYV-S08	15
VBD160L09.5-BG-02S10	●	2	30°	16	15.3	9	7.978 ⁽²⁾	S10	20.5	KEYV-S10	28

● Ground edge for finishing
● The tolerance of R : (1) ± 0.010 (2) ± 0.012

● : Stocked items
Packing Quantity = 2 pcs.

● Ball

VBD / VBE-BG type 4 flutes, 30° & 45° helix (for high precision)

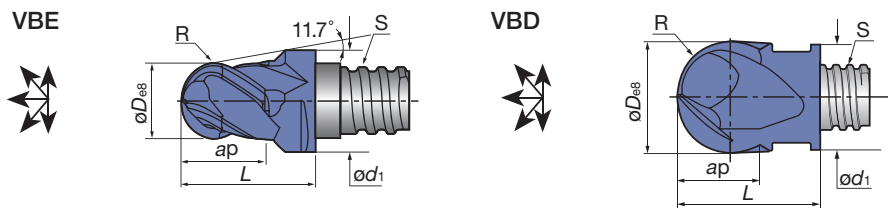

ap = Max. depth of cut
S = Connection screw size

Cat. No.	Grade AH725	No. of flutes	Helix angle	Dimensions (mm)						Wrench	Torque (N·m)
				øD	ød1	ap	R	S	L		
VBE060L05.5-BG-04S05	●	4	45°	6	8.0	5.5	2.987 ⁽¹⁾	S05	10.0	KEYV-S05	7
VBD080L05.0-BG-04S05	●	4	30°	8	7.7	5	3.982 ⁽¹⁾	S05	10.0	KEYV-S05	7
VBD100L07.0-BG-04S06	●	4	30°	10	9.7	7	4.982 ⁽¹⁾	S06	13.0	KEYV-S06	10
VBD120L09.0-BG-04S08	●	4	30°	12	11.7	9	5.978 ⁽²⁾	S08	16.5	KEYV-S08	15
VBD160L12.0-BG-04S10	●	4	30°	16	15.3	12	7.978 ⁽²⁾	S10	20.5	KEYV-S10	28
VBD200L15.0-BG-04S12	●	4	30°	20	18.3	15	9.972 ⁽²⁾	S12	25.5	KEYV-S12	28

- Ground edge for finishing
- The tolerance of R : (1) ± 0.010 (2) ± 0.012

VBB-SG type 2 flutes, 0° helix, spherical designed edge

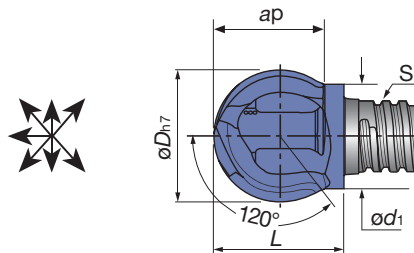

ap = Max. depth of cut
S = Connection screw size

Cat. No.	Grade AH725	No. of flutes	Helix angle	Dimensions (mm)					Wrench	Torque (N·m)
				øD	ød1	ap	S	L		
VBB100L08.0-SG-02S05	●	2	0°	10	7.6	8	S05	10.1	KEYV-S05	7
VBB120L09.6-SG-02S06	●	2	0°	12	9.6	9.6	S06	11.6	*KEYV-S08	10
VBB160L12.9-SG-02S08	●	2	0°	16	11.5	12.9	S08	15.4	*KEYV-S10	15
VBB200L16.1-SG-02S10	●	2	0°	20	15.2	16.1	S10	18.5	KEYV-S10	28

- For pull-cutting on the vertical wall
- * Some heads require different size of wrench.

VBE-BGA type 2 flutes, 45° helix, for aluminium machining

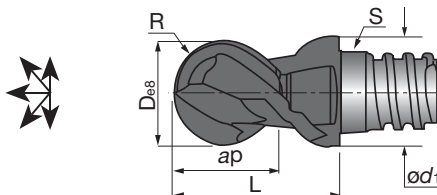

ap = Max. depth of cut
S = Connection screw size

Cat. No.	Grade KS15F	No. of flutes	Helix angle	Dimensions (mm)						Wrench	Torque (N·m)
				øD	ød1	ap	R	S	L		
VBE080L05.0-BGA02S05	●	2	45°	8	7.7	5	3.982 ⁽¹⁾	S05	10.0	KEYV-S05	7
VBE100L07.0-BGA02S06	●	2	45°	10	9.7	7	4.982 ⁽¹⁾	S06	13.0	KEYV-S06	10
VBE120L09.0-BGA02S08	●	2	45°	12	11.7	9	5.987 ⁽²⁾	S08	16.5	KEYV-S08	15
VBE160L12.0-BGA02S10	●	2	45°	16	15.3	12	7.978 ⁽²⁾	S10	20.5	KEYV-S10	28
VBE200L15.0-BGA02S12	●	2	45°	20	18.3	15	9.972 ⁽²⁾	S12	25.5	KEYV-S12	28

- Ground edge for finishing
- The tolerance of R : (1) ± 0.010 (2) ± 0.012

● : Stocked items
Packing Quantity = 2 pcs.

Toroidal

VRB / VRC type 2 flutes, 0° / 15° helix, 5° / 7° relief angle

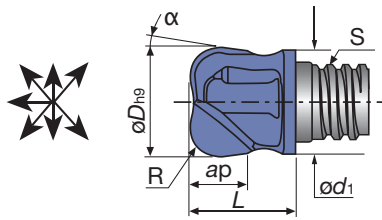

ap = Max. depth of cut
S = Connection screw size

Cat. No.	Grade AH725	No. of flutes	Helix angle	Dimensions (mm)							Wrench	Torque (N·m)
				ϕD	ϕd_1	ap	R	α	S	L		
VRC100L07.0R05-02S06	●	2	15°	10	9.5	7	0.5	5°	S06	12.4	KEYV-S06	10
VRC100L07.0R10-02S06	●	2	15°	10	9.5	7	1.0	5°	S06	12.4		
VRB100L06.0R20-02S06	●	2	0°	10	9.2	6	2.0	7°	S06	12.4		
VRB120L05.7R30-02S06	●	2	0°	12	9.5	5.7	3.0	7°	S06	9.1		
VRB120L05.4R40-02S06	●	2	0°	12	9.5	5.4	4.0	7°	S06	9.1		
VRB120L06.3R16-02S08	●	2	0°	12	11.5	5.9	1.6	7°	S08	11.1	KEYV-S08	15
VRB120L06.2R20-02S08	●	2	0°	12	11.5	6.2	2.0	7°	S08	11.1		
VRB120L06.1R25-02S08	●	2	0°	12	11.5	5.8	2.5	7°	S08	11.1		
VRB120L06.1R30-02S08	●	2	0°	12	11.5	5.7	3.0	7°	S08	11.1		
VRB120L05.9R40-02S08	●	2	0°	12	11.5	5.5	4.0	7°	S08	11.1		
VRB160L08.0R50-02S10	●	2	0°	16	15.2	8	5.0	7°	S10	20.2	KEYV-S10	28
VRB200L11.1R30-02S12	●	2	0°	20	18.3	11	3.0	7°	S12	17.0	KEYV-S12	
VRB200L11.5R40-02S12	●	2	0°	20	18.3	11.3	4.0	7°	S12	17.3		
VRB200L11.5R50-02S12	●	2	0°	20	18.3	11.3	5.0	7°	S12	17.3		
VRB200L11.4R60-02S12	●	2	0°	20	18.3	11.2	6.0	7°	S12	17.3		
VRB200L11.3R80-02S12	●	2	0°	20	18.3	11.1	8.0	7°	S12	17.3		

● For hardened steels, suitable for contouring operation

VRD type 6 flutes, 30° helix, 7° back taper sided

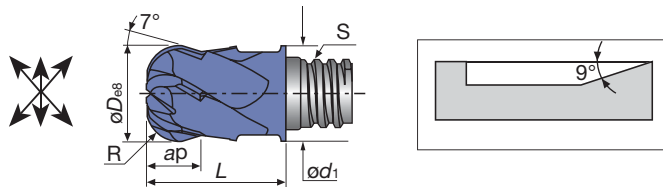

ap = Max. depth of cut
S = Connection screw size

Cat. No.	Grade AH725	No. of flutes	Helix angle	Dimensions (mm)						Wrench	Torque (N·m)
				ϕD	ϕd_1	ap	R	S	L		
VRD080L04.0R20-06S05	●	6	30°	8	7.7	4	2.0	S05	10.0	KEYV-S05	7
VRD100L05.0R30-06S06	●	6	30°	10	9.7	5	3.0	S06	13.0	KEYV-S06	10
VRD120L07.0R40-06S08	●	6	30°	12	11.7	7	4.0	S08	16.5	KEYV-S08	15
VRD160L09.0R50-06S10	●	6	30°	16	15.3	9	5.0	S10	20.5	KEYV-S10	28

● For hardened steels

● : Stocked items
Packing Quantity = 2 pcs.

Toroidal

VFX type

2 flutes, 0° helix, for high feed milling

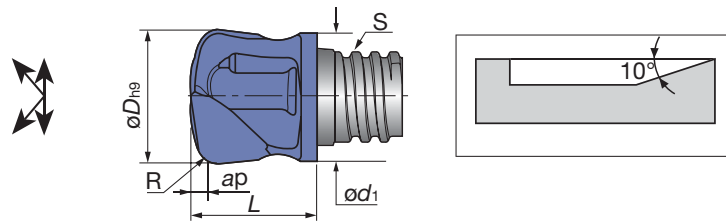

ap = Max. depth of cut
 S = Connection screw size

Cat. No.	Grade AH725	No. of flutes	Helix angle	Dimensions (mm)						Wrench	Torque (N·m)
				ϕD	ϕd_1	ap	$R^{(1)}$	S	L		
VFX100L00.6R20-02S06	●	2	0°	10	9.6	0.6	2.0	S06	12.5	KEYV-S06	10
VFX120L01.0R25-02S08	●	2	0°	12	11.5	1.0	2.5	S08	11.1	KEYV-S08	15
VFX160L01.1R30-02S10	●	2	0°	16	15.2	1.1	3.0	S10	20.0	KEYV-S10	28
VFX200L01.5R33-02S12	●	2	0°	20	18.3	1.5	3.3	S12	17.5	KEYV-S12	28

(1) Corner radius for CAM programming

Drilling

VCP type

2 flutes, 0° helix, for spot drilling, chamfering and countersinking

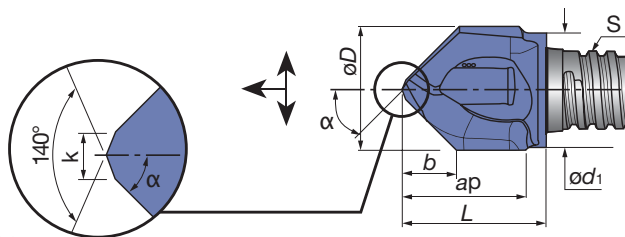

b = Max. hole depth
 ap = Max. depth of cut
 S = Connection screw size

Point angle = 60°

Cat. No	Grade AH725	No. of flutes	Helix angle	Dimensions (mm)								Wrench	Torque (N·m)
				ϕD	ϕd_1	ap	b	S	L	k	α		
VCP100L09.5A30-02S06	●	2	0°	10.0	9.5	8.5	7.5	S06	11.75	1.5	30°	KEYV-S06	10
VCP120L12.0A30-02S08	●	2	0°	12.0	11.5	11	9.2	S08	15.4	1.5	30°	KEYV-S08	15
VCP160L15.0A30-02S10	●	2	0°	16.0	15.2	16	12.0	S10	20.2	2.5	30°	KEYV-S10	28

- Min. chamfering: $\phi 1.5$ mm
- Tolerance ϕD : h10

Point angle = 90°

Cat. No	Grade AH725	No. of flutes	Helix angle	Dimensions (mm)								Wrench	Torque (N·m)
				ϕD	ϕd_1	ap	b	S	L	k	α		
VCP080L07.7A45-02S05	●	2	0°	8.0	7.6	7.5	3.7	S05	9.75	1.0	45°	KEYV-S05	7
VCP083L07.9A45-02S05	●	2	0°	8.3	7.6	7.5	3.8	S05	10.0	1.0	45°		
VCP100L09.0A45-02S06	●	2	0°	10.0	9.5	9.5	4.4	S06	11.75	1.5	45°	KEYV-S06	10
VCP104L09.0A45-02S06 ⁽¹⁾	●	2	0°	10.4	9.5	9.5	4.6	S06	11.75	1.5	45°		
VCP120L12.0A45-02S08	●	2	0°	12.0	11.5	11.5	5.4	S08	15.4	1.5	45°	KEYV-S08	15
VCP124L12.0A45-02S08 ⁽¹⁾	●	2	0°	12.4	11.5	11.5	5.6	S08	15.4	1.5	45°		
VCP160L15.0A45-02S10	●	2	0°	16.0	15.2	15	7.1	S10	18.8	1.5	45°	KEYV-S10	28
VCP165L15.0A45-02S10	●	2	0°	16.5	15.2	15	7.1	S10	18.8	1.5	45°		

- Min. chamfering: $\phi 1.5$ mm
 - Tolerance ϕD : z9
- (1) For countersinking with DIN74

Point angle = 120°

Cat. No	Grade AH725	No. of flutes	Helix angle	Dimensions (mm)								Wrench	Torque (N·m)
				ϕD	ϕd_1	ap	b	S	L	k	α		
VCP100L09.5A60-02S06	●	2	0°	10.0	9.5	9.5	2.7	S06	12.7	1.5	60°	KEYV-S06	10
VCP120L12.0A60-02S08	●	2	0°	12.0	11.5	11.5	3.3	S08	15.2	1.5	60°	KEYV-S08	15
VCP160L15.5A60-02S10	●	2	0°	16.0	15.2	16	4.4	S10	19.9	1.5	60°	KEYV-S10	28

- Min. chamfering: $\phi 1.5$ mm
- Tolerance ϕD : h10

● : Stocked items
Packing Quantity = 2 pcs.

● **Drilling**

VDP type 2 flutes, for center drilling (DIN332)

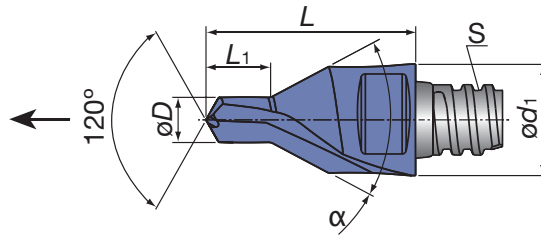

ap = Max. depth of cut
S = Connection screw size

Cat. No.	Grade AH725	No. of flutes	Helix angle	Dimensions (mm)						Wrench	Torque (N·m)
				ϕD	ϕd_1	L_1	S	L	α		
VDP328L04.6A30-02S05	●	2	-	3.28	8	4.6	S05	15.0	59.5°	KEYV-S05	7
VDP412L05.9A30-02S06	●	2	-	4.12	10	5.9	S06	19.0	59.5°	KEYV-S06	10
VDP513L07.2A30-02S08	●	2	-	5.13	12	7.2	S08	23.0	59.5°	KEYV-S08	15
VDP646L08.9A30-02S10	●	2	-	6.46	16	8.9	S10	28.0	59.5°	KEYV-S10	28

VGC type 2 flutes, 0° helix, for counter boring

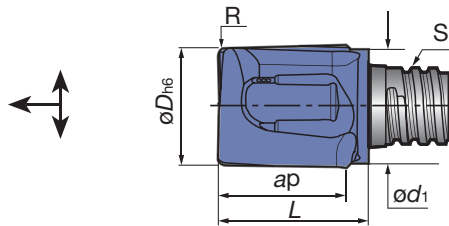

ap = Max. depth of cut
S = Connection screw size

Cat. No.	Grade AH725	No. of flutes	Helix angle	Dimensions (mm)						Wrench	Torque (N·m)
				ϕD	ϕd_1	ap	R	S	L		
VGC078L08.0R02-02S05	●	2	0°	7.8	7.6	8	0.2	S05	10.0	KEYV-S05	7
VGC080L08.0R04-02S05	●	2	0°	8.0	7.6	8	0.4	S05	10.0		
VGC080L08.0R10-02S05	●	2	0°	8.0	7.6	8	1.0	S05	10.0		
VGC080L08.0R20-02S05	●	2	0°	8.0	7.6	8	2.0	S05	10.0		
VGC098L09.0R03-02S06	●	2	0°	9.8	9.5	9.5	0.3	S06	12.4	KEYV-S06	10
VGC100L09.0R04-02S06	●	2	0°	10.0	9.5	9.5	0.4	S06	12.4		
VGC100L09.0R10-02S06	●	2	0°	10.0	9.5	9.5	1.0	S06	12.4		
VGC100L09.0R20-02S06	●	2	0°	10.0	9.5	9.5	2.0	S06	12.4		
VGC117L10.0R03-02S08	●	2	0°	11.7	11.5	10	0.3	S08	14.2	KEYV-S08	15
VGC120L10.0R04-02S08	●	2	0°	12.0	11.5	10	0.4	S08	14.2		
VGC120L10.0R10-02S08	●	2	0°	12.0	11.5	10	1.0	S08	14.2		
VGC120L10.0R20-02S08	●	2	0°	12.0	11.5	10	2.0	S08	14.2		
VGC157L15.0R03-02S10	●	2	0°	15.7	15.2	15	0.3	S10	19.0	KEYV-S10	28
VGC160L15.0R04-02S10	●	2	0°	16.0	15.2	15	0.4	S10	19.0		
VGC160L15.0R08-02S10	●	2	0°	16.0	15.2	15	0.8	S10	19.0		

● Can drill with step feed

● : Stocked items
Packing Quantity = 2 pcs.

● Chamfering

VCA type

4 / 6 flutes, 0° helix, chamfering and countersinking (without center edge)

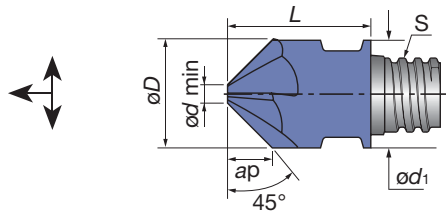

ap = Max. depth of cut
S = Connection screw size

Cat. No.	Grade AH725	No. of flutes	Helix angle	Dimensions (mm)						Wrench	Torque (N·m)
				øD	ød1	ap	ødmin	S	L		
VCA100L04.0A45-04S06	●	4	0°	10.0	10.0	4	1.95	S06	13.00	KEYV-S06	10
VCA120L05.0A45-04S08	●	4	0°	12.0	16.0	5	1.95	S08	16.50	KEYV-S08	15
VCA127L05.3A45-04S08	●	4	0°	12.7	12.7	5.3	1.98	S08	16.50		
VCA160L06.5A45-06S10	●	6	0°	16.0	16.0	6.5	3.00	S10	20.30	KEYV-S10	28
VCA200L07.5A45-06S12	●	6	0°	20.0	18.3	7.5	5.00	S12	25.50	KEYV-S12	28

VCW type

2 flutes, 0° helix, for double chamfering

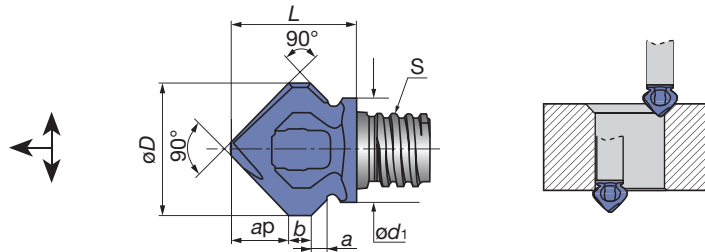

ap = Max. depth of cut
S = Connection screw size

Cat. No.	Grade AH725	No. of flutes	Helix angle	Dimensions (mm)						Wrench	Torque (N·m)	
				øD	ød1	ap	a	b	S			L
VCW118L05.0A45-02S06	●	2	0°	11.8	9.3	5.0	1.2	2.0	S06	11.20	*KEYV-S08	10

- Available for chamfering of reverse side
- * Some heads require different size of wrench.

VCR type

2 flutes, 0° helix, for concave radii milling

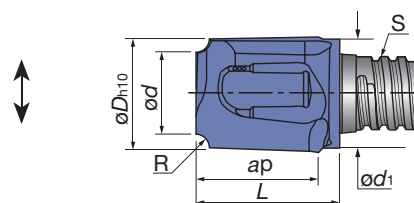

ap = Max. depth of cut
S = Connection screw size

Cat. No.	Grade AH725	No. of flutes	Helix angle	Dimensions (mm)						Wrench	Torque (N·m)	
				øD	ød1	ød	ap	R	S			L
VCR080L07.5R10-02S05	●	2	0°	8.0	7.6	5.8	7.5	1.0	S05	10.5	KEYV-S05	7
VCR100L09.5R16-02S06	●	2	0°	10.0	9.5	6.8	9.5	1.6	S06	12.5	KEYV-S06	10
VCR100L09.5R25-02S06	●	2	0°	10.0	9.5	5.1	9.5	2.5	S06	12.5		
VCR127L12.0R30-02S08	●	2	0°	12.7	12.2	6.5	12	3.0	S08	15.6	KEYV-S08	15
VCR127L12.0R40-02S08	●	2	0°	12.7	12.2	4.7	12	4.0	S08	15.6		
VCR160L15.0R50-02S10	●	2	0°	16.0	15.2	6.2	15	5.0	S10	19.1	KEYV-S10	28
VCR200L07.0R60-02S12	●	2	0°	20.0	18.3	8.0	7.0	6.0	S12	17.4	KEYV-S12	28

● : Stocked items
Packing Quantity = 2 pcs.

● Grooving

VST type 3 flutes, for grooving

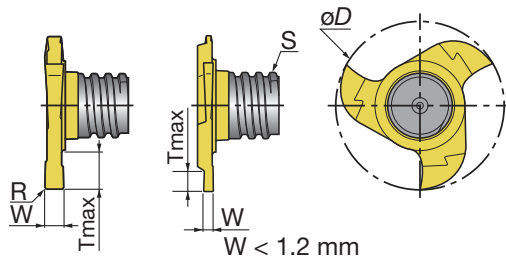

S = Connection screw size

Cat. No.	Grade GH130	No. of flutes	Helix angle	Dimensions (mm)					Wrench	Torque (N·m)
				øD	W ^{±0.02}	R	S	Tmax		
VST157W1.50R010-3S06	●	3	-	15.7	1.50	0.10	S06	2.8	KEYV-177	10
VST157W1.57R020-3S06	●	3	-	15.7	1.57	0.20	S06	2.8		
VST157W2.00R020-3S06	●	3	-	15.7	2.00	0.20	S06	2.8		
VST157W2.39R020-3S06	●	3	-	15.7	2.39	0.20	S06	2.8		
VST157W2.50R020-3S06	●	3	-	15.7	2.50	0.20	S06	2.8		
VST157W3.00R020-3S06	●	3	-	15.7	3.00	0.20	S06	2.8		
VST157W3.17R020-3S06	●	3	-	15.7	3.17	0.20	S06	2.8		
VST177W1.20R005-3S06	●	3	-	17.7	1.20 ⁽¹⁾	0.05	S06	3.8		
VST177W1.40R005-3S06	●	3	-	17.7	1.40 ⁽¹⁾	0.05	S06	3.8		
VST177W1.50R010-3S06	●	3	-	17.7	1.50	0.10	S06	3.8		
VST177W1.57R020-3S06	●	3	-	17.7	1.57	0.20	S06	3.8		
VST177W1.70R005-3S06	●	3	-	17.7	1.70 ⁽¹⁾	0.05	S06	3.8		
VST177W2.00R020-3S06	●	3	-	17.7	2.00	0.20	S06	3.8		
VST177W2.20R110-3S06	●	3	-	17.7	2.20	1.10	S06	3.8		
VST177W2.39R020-3S06	●	3	-	17.7	2.39	0.20	S06	3.8		
VST177W2.50R020-3S06	●	3	-	17.7	2.50	0.20	S06	3.8		
VST177W3.00R020-3S06	●	3	-	17.7	3.00	0.20	S06	3.8		
VST177W3.17R020-3S06	●	3	-	17.7	3.17	0.20	S06	3.8		

(1) W is based on DIN471 / 472

● : Stocked items
Packing Quantity = 2 pcs.

Grooving

VST type

4 / 6 flutes, for grooving

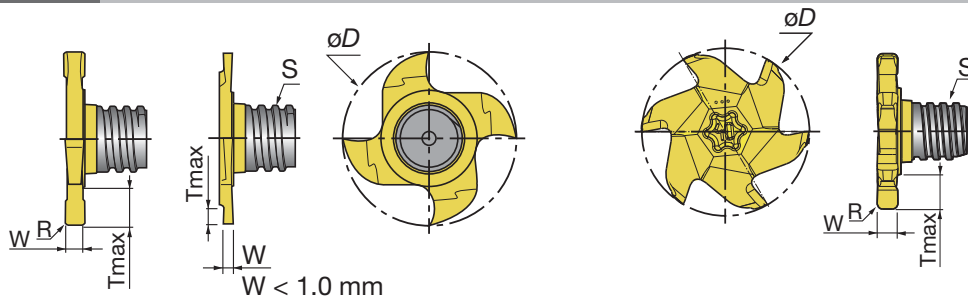

S = Connection screw size

Cat. No.	Grade GH130	No. of flutes	Helix angle	Dimensions (mm)					Wrench	Torque (N·m)
				$\varnothing D$	$W_{\pm 0.02}$	R	S	Tmax		
VST217W0.76R000-4S08	●	4	-	21.7	0.76 ⁽¹⁾	0.00	S08	1.5	KEYV-217	15
VST217W0.86R000-4S08	●	4	-	21.7	0.86 ⁽¹⁾	0.00	S08	1.7		
VST217W0.96R000-4S08	●	4	-	21.7	0.96 ⁽¹⁾	0.00	S08	1.9		
VST217W1.00R005-4S08	●	4	-	21.7	1.00	0.05	S08	2.0		
VST217W1.20R005-4S08	●	4	-	21.7	1.20 ⁽¹⁾	0.05	S08	4.5		
VST217W1.40R005-4S08	●	4	-	21.7	1.40 ⁽¹⁾	0.05	S08	4.5		
VST217W1.57R000-4S08	●	4	-	21.7	1.57	0.00	S08	4.5		
VST217W1.70R010-4S08	●	4	-	21.7	1.70 ⁽¹⁾	0.10	S08	4.5		
VST217W1.95R020-4S08	●	4	-	21.7	1.95 ⁽¹⁾	0.20	S08	4.5		
VST217W2.00R020-4S08	●	4	-	21.7	2.00	0.20	S08	4.5		
VST217W2.25R020-4S08	●	4	-	21.7	2.25 ⁽¹⁾	0.20	S08	4.5		
VST217W2.39R020-4S08	●	4	-	21.7	2.39	0.20	S08	4.5		
VST217W2.50R020-4S08	●	4	-	21.7	2.50	0.20	S08	4.5		
VST217W2.75R020-4S08	●	4	-	21.7	2.75 ⁽¹⁾	0.20	S08	4.5		
VST217W3.00R020-4S08	●	4	-	21.7	3.00	0.20	S08	4.5		
VST217W3.17R020-4S08	●	4	-	21.7	3.17	0.20	S08	4.5		
VST217W3.25R020-4S08	●	4	-	27.7	3.25 ⁽¹⁾	0.20	S08	4.5		
VST217W4.00R020-4S08	●	4	-	27.7	4.00	0.20	S08	4.5		
VST217W4.25R020-4S08	●	4	-	21.7	4.25 ⁽¹⁾	0.20	S08	4.5		
VST217W4.75R020-4S08	●	4	-	21.7	4.75	0.20	S08	4.5		
VST217W5.25R020-4S08	●	4	-	21.7	5.25 ⁽¹⁾	0.20	S08	4.5		
VST277W2.50R020-6S10	●	6	-	27.7	2.50	0.20	S10	6.0	KEYV-T40L	28
VST277W5.25R020-6S10	●	6	-	27.7	5.25	0.20	S10	6.0		
VST277W10.0R020-6S10	●	6	-	27.7	10.00	0.20	S10	6.0		

(1) W is based on DIN471 / 472

VST-A45 type

3 / 4 flutes, for chamfering

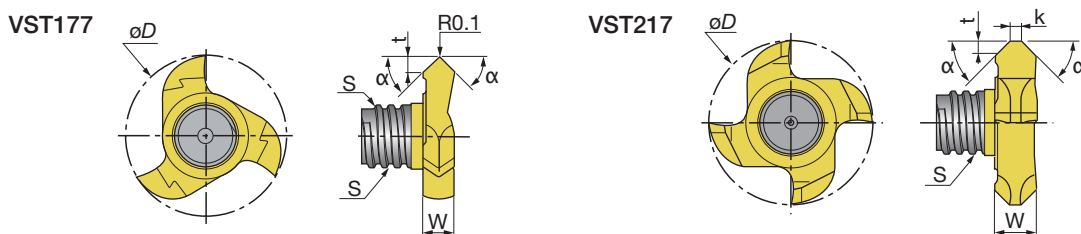

S = Connection screw size

Cat. No.	Grade GH130	No. of flutes	Helix angle	Dimensions (mm)						Wrench	Torque (N·m)
				$\varnothing D$	W	α	S	t	K		
VST177L01.40A45-3S06	●	3	-	17.7	3.40	45°	S06	1.4	-	KEYV-177	10
VST217L01.70A45-4S08	●	4	-	21.7	5.50	45°	S08	1.7	1.5	KEYV-217	15

● : Stocked items
Packing Quantity = 2 pcs.

● Grooving

VTB type 6 flutes, for grooving (for T-slotting)

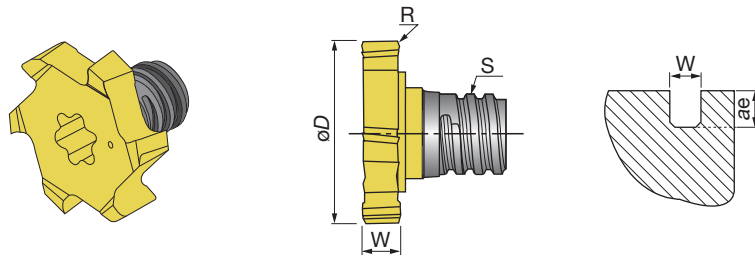

S = Connection screw size

Cat. No.	Grade GH130	No. of flutes	Helix angle	Dimensions (mm)					Wrench	Torque (N·m)	
				$\phi D^{+0}_{-0.05}$	$W^{\pm 0.02}$	ae	S	R			
VTB135W3.00R04-06S05	●	6	-	13.5	3	2.65	S05	0.4	KEYV-T20	7	
VTB135W4.00R04-06S05	●	6	-	13.5	4	2.65	S05	0.4			
VTB160W2.00R04-06S06	●	6	-	16.0	2	3.00	S06	0.4			
VTB160W3.00R04-06S06	●	6	-	16.0	3	3.00	S06	0.4	KEYV-T25	10	
VTB160W4.00R04-06S06	●	6	-	16.0	4	3.00	S06	0.4			
VTB165W2.00R04-06S06	●	6	-	16.5	2	3.25	S06	0.4	KEYV-T20		
VTB165W3.00R04-06S06	●	6	-	16.5	3	3.25	S06	0.4	KEYV-T25		
VTB165W4.00R04-06S06	●	6	-	16.5	4	3.25	S06	0.4			
VTB195W4.00R04-06S08	●	6	-	19.5	4	3.45	S08	0.4	KEYV-T30L		15
VTB195W5.00R04-06S08	●	6	-	19.5	5	3.45	S08	0.4			
VTB195W6.00R04-06S08	●	6	-	19.5	6	3.45	S08	0.4			
VTB225W5.00R04-06S08	●	6	-	22.5	5	4.95	S08	0.4	KEYV-T40L		
VTB225W6.00R04-06S08	●	6	-	22.5	6	4.95	S08	0.4			
VTB225W8.00R04-06S08	●	6	-	22.5	8	4.95	S08	0.4			
VTB250W6.00R04-06S08	●	6	-	25.0	6	5.90	S08	0.4	KEYV-T50L	28	
VTB250W8.00R04-06S08	●	6	-	25.0	8	5.90	S08	0.4			
VTB250W5.00R04-06S10	●	6	-	25.0	5	4.30	S10	0.4			
VTB250W6.00R04-06S10	●	6	-	25.0	6	4.30	S10	0.4			
VTB250W8.00R04-06S10	●	6	-	25.0	8	4.30	S10	0.4			

● High density type

VTB-15 type 6 flutes, for chamfered grooving (for T-slotting)

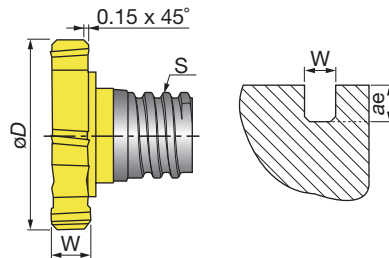

S = Connection screw size

Cat. No.	Grade GH130	No. of flutes	Helix angle	Dimensions (mm)					Wrench	Torque (N·m)
				$\phi D^{+0}_{-0.05}$	$W^{\pm 0.05}$	ae	S	C		
VTB135W2.00C15-06S05	●	6	-	13.5	2.5	2.65	S05	0.15	KEYV-T20	7

● High density type

● : Stocked items
Packing Quantity = 2 pcs.

Shanks - Specification

VSSD type

Straight shank and neck

Cylindrical type

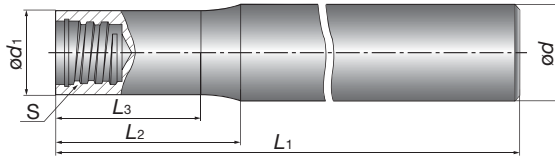

Weldon type



S = Connection screw size

Cat. No.	Stock	Dimensions (mm)						Shank style	Shank material
		ød	ød1	L1	L2	L3	S		
VSSD08L060S05-S	●	8	7.6	60	15	12.5	S05	Cylindrical	Steel
VSSD10L075S06-S	●	10	9.6	75	20	17.5	S06		
VSSD12L090S08-S	●	12	11.5	90	16	13.5	S08		
VSSD16L100S10-S	●	16	15.2	100	20	18	S10		
VSSD20L120S12-S	●	20	18.3	120	25	20.5	S12		
VSSD08L070S05-C	★	8	7.6	70	20	18.5	S05	Cylindrical	Carbide
VSSD08L090S05-C	★	8	7.6	90	40	38.5	S05		
VSSD08L110S05-C	★	8	7.6	110	60	58.5	S05		
VSSD10L070S06-C	★	10	9.6	70	20	18.5	S06		
VSSD10L090S06-C	★	10	9.6	90	40	38.5	S06		
VSSD10L110S06-C	★	10	9.6	110	60	58.5	S06		
VSSD10L150S06-C	★	10	9.6	150	100	98.5	S06		
VSSD12L070S08-C	★	12	11.5	70	20	18	S08		
VSSD12L090S08-C	★	12	11.5	90	40	38	S08		
VSSD12L110S08-C	★	12	11.5	110	60	58	S08		
VSSD12L130S08-C	★	12	11.5	130	80	78	S08		
VSSD16L090S10-C	★	16	15.2	90	40	38	S10		
VSSD16L110S10-C	★	16	15.2	110	60	58	S10		
VSSD16L130S10-C	★	16	15.2	130	80	78	S10		
VSSD16L150S10-C	★	16	15.2	150	100	98	S10		
VSSD20L090S12-C	★	20	18.3	90	40	37	S12		
VSSD20L130S12-C	★	20	18.3	130	80	77	S12		
VSSD20L200S12-C	★	20	18.3	200	120	117	S12		
VSSD12L055W05-S	●	12	7.6	55	3.8	-	S05	Weldon	Steel
VSSD16L065W06-S	●	16	9.5	65	6	-	S06		
VSSD16L065W08-S	●	16	11.5	65	4	-	S08		
VSSD20L070W10-S	●	20	15.2	70	4	-	S10		
VSSD25L075W12-S	●	25	18.3	75	7.2	-	S12		

● : Stocked items
★ : Available from 2010

VSSD-W-A type Straight shank and neck with coolant hole

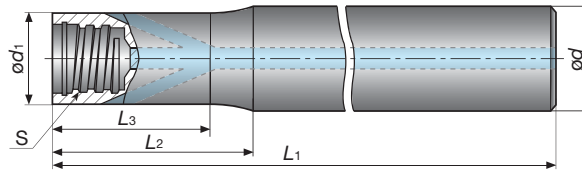

S = Connection screw size

Cat. No.	Stock	Dimensions (mm)						Shank material
		ϕd	ϕd_1	L_1	L_2	L_3	S	
VSSD10L070S06-W-A	●	10	9.6	70	20	19	S06	Tungsten
VSSD10L090S06-W-A	●	10	9.6	90	40	39	S06	
VSSD10L110S06-W-A	●	10	9.6	110	60	59	S06	
VSSD12L070S08-W-A	●	12	11.5	70	20	19	S08	
VSSD12L090S08-W-A	●	12	11.5	90	40	39	S08	
VSSD12L110S08-W-A	●	12	11.5	110	60	59	S08	
VSSD12L130S08-W-A	●	12	11.5	130	80	79	S08	
VSSD16L070S10-W-A	●	16	15.2	70	20	18.5	S10	
VSSD16L090S10-W-A	●	16	15.2	90	40	36.5	S10	
VSSD16L110S10-W-A	●	16	15.2	110	60	58.5	S10	
VSSD16L130S10-W-A	●	16	15.2	130	80	78.5	S10	
VSSD20L090S12-W-A	●	20	18.3	90	40	37	S12	
VSSD20L130S12-W-A	●	20	18.3	130	80	77	S12	

● : Stocked items

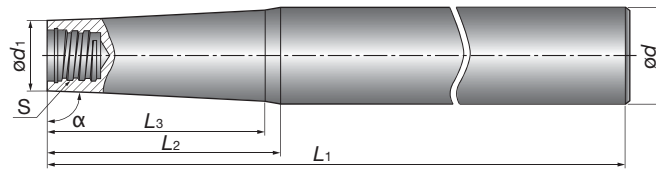
VTSD type
Straight shank and taper neck

S = Connection screw size

Cat. No.	Stock	Dimensions (mm)							Shank material
		α	ϕd	ϕd_1	L_1	L_2	L_3	S	
VTSD12L080S05-S	●	85°	12	7.6	80	25	-	S05	Steel
VTSD12L100S05-S	●	89°	12	7.6	100	35	29	S05	
VTSD16L125S06-S	●	85°	16	9.6	125	34	31	S06	
VTSD16L160S06-S	●	89°	16	9.6	160	55	46.5	S06	
VTSD16L140S08-S	●	85°	16	11.5	140	22	19	S08	
VTSD20L170S08-S	●	89°	20	11.5	170	80	69.5	S08	
VTSD20L140S10-S	●	85°	20	15.2	140	27.5	-	S10	
VTSD25L170S10-S	●	85°	25	15.2	170	56	-	S10	
VTSD20L190S10-S	●	89°	20	15.2	190	80	73	S10	
VTSD25L160S12-S	●	85°	25	18.3	160	40	-	S12	
VTSD32L190S12-S	●	85°	32	18.3	190	80	-	S12	
VTSD25L210S12-S	●	89°	25	18.3	210	100	94.5	S12	
VTSD12L110S05-C	★	89°	12	7.6	110	60	56	S05	Carbide
VTSD12L130S05-C	★	89°	12	7.6	130	80	77	S05	
VTSD16L150S05-C	★	89°	16	7.6	150	100	91	S05	
VTSD16L150S06-C	★	89°	16	9.6	150	100	98	S06	
VTSD16L170S06-C	★	89°	16	9.6	170	120	116.5	S06	
VTSD16L130S08-C	★	89°	16	11.5	130	80	76.5	S08	
VTSD16L150S08-C	★	89°	16	11.5	150	100	98	S08	
VTSD20L170S08-C	★	89°	20	11.5	170	120	112	S08	
VTSD20L170S10-C	★	89°	20	15.2	170	120	119	S10	
VTSD20L190S10-C	★	89°	20	15.2	190	140	-	S10	
VTSD20L210S10-C	★	89°	20	15.2	210	160	-	S10	
VTSD25L180S12-C	★	89°	25	18.3	180	120	115	S12	
VTSD25L250S12-C	★	89°	25	18.3	250	140	136.5	S12	

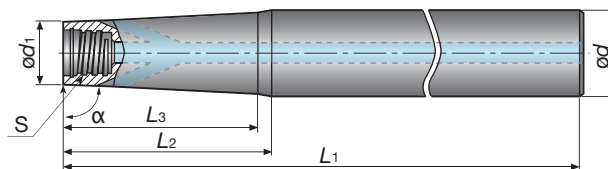
VTSD-W-A type
Straight shank and taper neck with coolant hole

S = Connection screw size

Cat. No.	Stock	Dimensions (mm)							Shank material
		α	ϕd	ϕd_1	L_1	L_2	L_3	S	
VTSD12L110S06-W-A	●	89°	12	9.6	110	60	59	S06	Tungsten
VTSD16L170S06-W-A	●	89°	16	9.6	170	120	116	S06	

 ● : Stocked items
 ★ : Available from 2010

VSC type Straight shank for VST type grooving heads

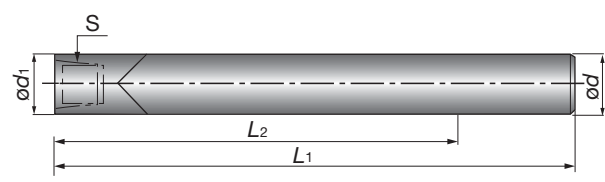

S = Connection screw size

Cat. No.	Stock	Dimensions (mm)				Shank material
		$\varnothing d$	L_1	L_2	S	
VSC100L100S06-C	★	10.0	100	80	S06	Carbide
VSC120L100S08-C	★	12.0	100	78	S08	

Note:

- In VSC-C type carbide shank, the wrench for VST grooving head is included.
- For VSC-C type shank, just VST grooving head is recommended. If other heads are used on the VSC-C shank, the depth of cut must be smaller than the max. ap in each head. The VSC-C type shank does not have external clearance, so the shank may interfere with the work piece.

VSTD type Straight shank for VTB type grooving heads

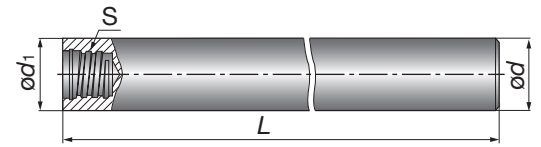

S = Connection screw size

Cat. No.	Stock	Dimensions (mm)				Shank material
		$\varnothing d$	$\varnothing d_1$	L	S	
VSTD08L070S05-S	●	8	8	70	S05	Steel
VSTD10L080S06-S	●	10	10	80	S06	
VSTD12L090S08-S	●	12	12	90	S08	
VSTD16L100S10-S	●	16	16	100	S10	

Note:

- For VSTD type shank, just VTB grooving head is recommended. If other heads are used on the VSTD shank, the depth of cut must be smaller than the max. ap in each head. The VSTD type shank does not have external clearance, so the shank may interfere with the work piece.

VAD-M type Adapters of TungFlex

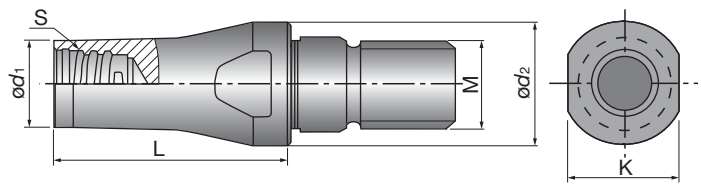

S = Connection screw size

Cat. No.	Stock	Dimensions (mm)						Shank material
		$\varnothing d_1$	$\varnothing d_2$	L	S	M	K	
VAD130L016S08-S-M8	●	11.7	13	16	S08	M8	11	Steel
VAD130L025S08-S-M8	●	11.7	13	25	S08	M8	11	
VAD180L020S08-S-M10	●	11.7	18	20	S08	M10	13	
VAD180L025S08-S-M10	●	11.7	18	25	S08	M10	11	
VAD210L020S08-S-M12	●	11.7	21	20	S08	M12	12.75	
VAD210L025S08-S-M12	●	11.7	21	25	S08	M12	12.75	

• For TungHold (available from May 2010)

● : Stocked items
★ : Available from 2010

Designation System

Shank

V **SS** **D10** **L070** **S** **06** - **W** - **A**

1 2 3 4 5 6 7 8

1 Series	
V	TungMeister

2 Shank type	
SS	Straight neck
TS	Taper neck
SC	Grooving
ST	for T-Slotting
AD	TungFlex adaptor

3 Shank diameter (mm)	
D08	ø8
D10	ø10
D12	ø12
D16	ø16
D20	ø20
D25	ø25
VSC, VAD type	
100	ø10
120	ø12
130	ø13
180	ø18
210	ø21

4 Length (mm)	
L070	70

5 Shape of shank	
S	Cylindrical
W	Weldon

6 Connection screw size	
05	S05
06	S06
08	S08
10	S10
12	S12

7 Shank material	
S	Steel
C	Carbide
W	Tungsten

8 Additional feature	
A	with coolant hole
M	Screw size (TungFlex adapters)

Head

Square end mill

V **E** **E** **080** **L05.0** **R00** - **03** **S05**

1 2 3 4 5 6 7 8 9

Ball nose end mill

V **B** **D** **200** **L15.0** - **BG** - **04** **S12**

1 2 3 4 5 6 7 8 9

1 Series	
V	TungMeister

2 Cutting edge	
E	Square
B	Ball
R	Radius
FX	for high feed
CA	for chamfering
CP	Spot drilling
CW	for chamfering (front and back)
CR	for R chamfering
GC	for counter boring
DP	for center drilling
S	for grooving
T	for T-slot milling

3 Helix angle / Rake face	
B	0°
C	15°
D	30°
E	45°
F	60°
T	Land

4 Diameter (mm)	
060	ø6
200	ø20

5 Cutting edge length (mm)	
Length	
L07.0	7
L15.0	15
Groove width	
W1.50	1.5
W1.57	1.57
W10.0	10



6 Corner shape / Angle	
Nose radius	
R00	Sharp edge
R005	R0.05
R01	R0.1
R05	R0.5
R10	R1.0
Chamfer type	
C15	0.15 x 45°
C30	0.3 x 45°
C60	0.6 x 45°
Chamfering head	
A30	30°
A60	60°
R chamfering head	
R10	R1.0
R16	R1.6
Ball nose	
SG	Sphere / high precision
BM	Ball / general purpose
BG	Ball / high precision

7 Additional feature	
I	Irregular pitch
A	for aluminium
R	for roughing
C	Combined edge

8 The number of flutes	
General	
02	2
06	6
Grooving head VST type	
3	3
4	4

9 Connection screw size	
S05	S05
S06	S06
S08	S08
S10	S10
S12	S12

Wrench

Appearance	Cat. No.	Stock	Connection screw size	Torque (N·m)	Applicable head
	KEYV-S05	●	S05	7	Square Ball Radius Drilling Chamfering
	KEYV-S06	●	S06	10	
	KEYV-S08	●	S08	15	
	KEYV-S10	●	S10	28	
	KEYV-S12	●	S12	28	
	KEYV-177	●	S06	10	Grooving VST type
	KEYV-217	●	S08	15	
	KEYV-T20	●	S05	7	Grooving VTB type
			S06	10	
	KEYV-T25	●	S06	10	
	KEYV-T30L	●	S08	15	
	KEYV-T40L	●	S08	15	
	KEYV-T50L	●	S08	28	
S10					

Note:

- Optional parts

Standard Cutting Conditions

Shoulder milling / Slot milling

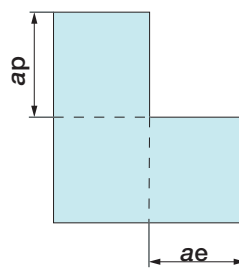
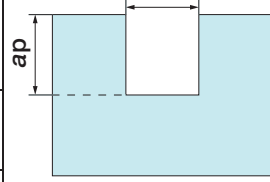
Work materials	Brinell hardness (HB)	Shoulder milling			Slot milling		
		Cutting Speed Vc (m/min)	Tool diameter øD (mm)	Feed rate fz (mm/t)	Cutting Speed Vc (m/min)	Tool diameter øD (mm)	Feed rate fz (mm/t)
Low carbon steels (S15C, SS400 etc.) (C15E etc.)	~ 200	170 ~ 190	ø6	0.03 ~ 0.07	170 ~ 190	ø6	0.03 ~ 0.04
High carbon steels (S45C, S55C etc.) (C45, C55 etc.)	200 ~ 300	140 ~ 150	ø8	0.05 ~ 0.09	140 ~ 150	ø8	0.03 ~ 0.04
Alloy steels (SCM440, SCr415 etc.) (42CrMo4, 17Cr3 etc.)	150 ~ 300	110 ~ 130	ø10	0.07 ~ 0.12	110 ~ 130	ø10	0.04 ~ 0.05
Stainless steels (SUS304, SUS316 etc.) (X5CrNi189 etc.)	-	80 ~ 160	ø12	0.08 ~ 0.13		ø12	0.05 ~ 0.06
Grey cast irons (FC250, FC300 etc.) (GG25, GG30 etc.)	150 ~ 250	130 ~ 180	ø16	0.09 ~ 0.15		ø16	0.06 ~ 0.08
Ductile cast irons (FCD400 etc.) (GGG40 etc.)			ø20	0.10 ~ 0.17	ø20	0.07 ~ 0.10	
Aluminium alloys (Si < 13%)	-	700 ~ 800	$ap = 0.6 \times \phi D$ $ae = 0.25 \times \phi D$ 			$ap = 0.5 \times \phi D$ $ae = 1 \times \phi D$ 	
High hardened steels	55HRC	30 ~ 40					

● Copy milling

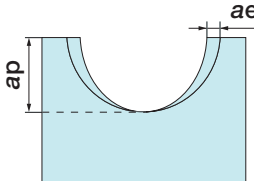
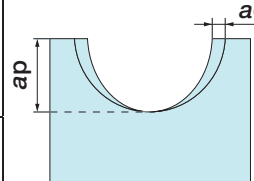
Work materials	Brinell hardness (HB)	Copy milling (for roughing)			Copy milling (for semi-finishing and finishing)																								
		Cutting Speed Vc (m/min)	Tool diameter øD (mm)	Feed rate fz (mm/t)	Cutting Speed Vc (m/min)	Tool diameter øD (mm)	Feed rate fz (mm/t)																						
Low carbon steels (S15C, SS400 etc.) (C15E etc.)	~ 200	170 ~ 190	<table border="1"> <tr><td>ø6</td><td>0.03 ~ 0.07</td></tr> <tr><td>ø8</td><td>0.03 ~ 0.09</td></tr> <tr><td>ø10</td><td>0.03 ~ 0.10</td></tr> <tr><td>ø12</td><td>0.04 ~ 0.11</td></tr> <tr><td>ø16</td><td>0.05 ~ 0.13</td></tr> <tr><td>ø20</td><td>0.05 ~ 0.17</td></tr> </table> <p> $ap = 0.3 \times \phi D$ $ae = 0.4 \times \phi D$ </p> 	ø6	0.03 ~ 0.07	ø8	0.03 ~ 0.09	ø10	0.03 ~ 0.10	ø12	0.04 ~ 0.11	ø16	0.05 ~ 0.13	ø20	0.05 ~ 0.17	170 ~ 190	<table border="1"> <tr><td>ø6</td><td>0.03 ~ 0.07</td></tr> <tr><td>ø8</td><td>0.03 ~ 0.09</td></tr> <tr><td>ø10</td><td>0.04 ~ 0.10</td></tr> <tr><td>ø12</td><td>0.04 ~ 0.11</td></tr> <tr><td>ø16</td><td>0.05 ~ 0.13</td></tr> <tr><td>ø20</td><td>0.05 ~ 0.17</td></tr> </table> <p> $ap = 0.1 \times \phi D$ $ae = 0.1 \times \phi D$ </p> 	ø6	0.03 ~ 0.07	ø8	0.03 ~ 0.09	ø10	0.04 ~ 0.10	ø12	0.04 ~ 0.11	ø16	0.05 ~ 0.13	ø20	0.05 ~ 0.17
ø6	0.03 ~ 0.07																												
ø8	0.03 ~ 0.09																												
ø10	0.03 ~ 0.10																												
ø12	0.04 ~ 0.11																												
ø16	0.05 ~ 0.13																												
ø20	0.05 ~ 0.17																												
ø6	0.03 ~ 0.07																												
ø8	0.03 ~ 0.09																												
ø10	0.04 ~ 0.10																												
ø12	0.04 ~ 0.11																												
ø16	0.05 ~ 0.13																												
ø20	0.05 ~ 0.17																												
High carbon steels (S45C, S55C etc.) (C45, C55 etc.)	200 ~ 300	140 ~ 150	140 ~ 150																										
Alloy steels (SCM440, SCr415 etc.) (42CrMo4, 17Cr3 etc.)	150 ~ 300	110 ~ 130	110 ~ 130																										
Stainless steels (SUS304, SUS316 etc.) (X5CrNi189 etc.)	-	80 ~ 160	80 ~ 160																										
Grey cast irons (FC250, FC300 etc.) (GG25, GG30 etc.)	150 ~ 250	130 ~ 180	130 ~ 180																										
Ductile cast irons (FCD400 etc.) (GGG40 etc.)			130 ~ 180																										
Aluminium alloys (Si < 13%)	-	700 ~ 800	700 ~ 800																										
High hardened steels	55HRC	30 ~ 40	30 ~ 40																										

● VTB / VST series for grooving

Work materials	Brinell hardness (HB)	VTB type		VST type	
		Cutting Speed Vc (m/min)	Feed rate fz (mm/t)	Cutting Speed Vc (m/min)	Feed rate fz (mm/t)
Low carbon steels (S15C, SS400 etc.) (C15E etc.)	~ 200	110 ~ 140	0.08 ~ 0.2	110 ~ 140	0.05 ~ 0.15
High carbon steels (S45C, S55C etc.) (C45, C55 etc.)	200 ~ 300	100 ~ 120	0.08 ~ 0.18	100 ~ 120	0.05 ~ 0.15
Alloy steels (SCM440, SCr415 etc.) (42CrMo4, 17Cr3 etc.)	150 ~ 300	100 ~ 120	0.08 ~ 0.15	100 ~ 120	0.05 ~ 0.15
Stainless steels (SUS304, SUS316 etc.) (X5CrNi189 etc.)	-	60 ~ 120	0.05 ~ 0.15	60 ~ 120	0.03 ~ 0.12
Grey cast irons (FC250, FC300 etc.) (GG25, GG30 etc.)	150 ~ 250	80 ~ 160	0.1 ~ 0.2	80 ~ 160	0.03 ~ 0.12
Ductile cast irons (FCD400 etc.) (GGG40 etc.)					
Aluminium alloys (Si < 13%)	-	700 ~ 800	0.1 ~ 0.2	700 ~ 800	0.05 ~ 0.15

■ Note

- Do not apply the lubricant to the threaded connection.
- Please use the proper "Wrench" according to the cutting head. The "Wrench" should be ordered separately.
- Too much torque may cause head breakage.
- When highly accurate machining is required the carbide shank is recommended.

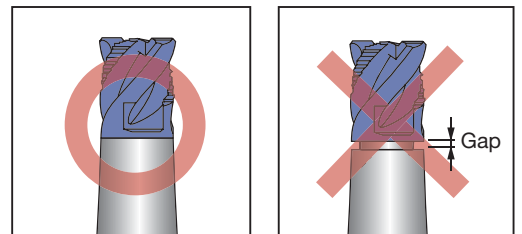

Practical Examples

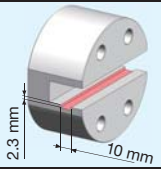
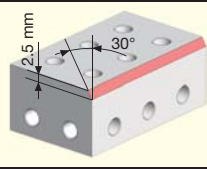
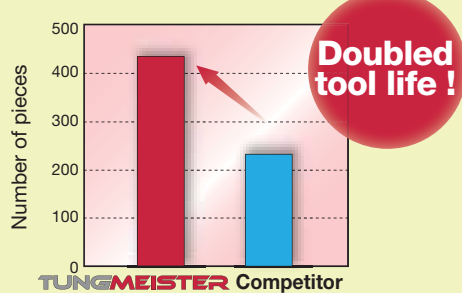
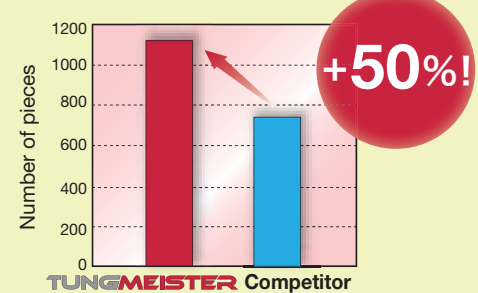
Work piece type		Machine parts	Machine parts
Current shank		VSTD10L080S06-S (Steel, ø10)	VSSD16L100S10-S (Steel, ø16)
Current head		VTB160W4.00R04-06S06 GH130 (ø16)	VCP160L15.0A30-02S10 AH725 (ø16)
Work material		Alloy steels (SCM440)	Stainless steels (SUS316)
			
Cutting conditions	Cutting speed: Vc (m/min)	110	160
	Feed rate: fz (mm/t)	0.07	0.1
	Depth of cut: ap (mm)	2.3	2.5
	Width of cut: ae (mm)	4 + 4 + 2	1.4
	Coolant	None	None
Results			
		TungMeister eliminates any need for regrinding.	TungMeister reduces changeover time to 1/10 compared to competitor's solid end mill.



Tungaloy Corporation

Tungaloy Corporation (Head office)

11-1 Yoshima-Kogyodanchi
Iwaki-city, Fukushima, 970-1144 Japan
Phone: +81-246-36-8501 Fax: +81-246-36-8542
<http://www.tungaloy.co.jp/>

Tungaloy America, Inc.

Phone: +1-630-227-3700 Fax: +1-630-227-0690
<http://www.tungaloyamerica.com/>

Tungaloy Canada

Phone: +1-519-758-5779 Fax: +1-519-758-5791
<http://www.tungaloyamerica.com/>

Tungaloy de Mexico S.A.

Phone: +52-449-929-5410 Fax: +52-449-929-5411
<http://www.tungaloyamerica.com/>

Tungaloy do Brasil Comércio de Ferramentas de Corte Ltda.

Phone: +55-19-38262757 Fax: +55-19-38262757
<http://www.tungaloy.co.jp/br/>

Tungaloy Germany GmbH

Phone: +49-2173-90420-0 Fax: +49-2173-90420-19
<http://www.tungaloy.de>

Tungaloy France S.A.S.

Phone: +33-1-6486-4300 Fax: +33-1-6907-7817
<http://www.tungaloy-eu.com/>

Tungaloy Italia S.r.l.

Phone: +39-02-252012-1 Fax: +39-02-252012-65
<http://www.tungaloy.co.jp/cz/>

Tungaloy Czech s.r.o

Phone: +420 532 123 391 Fax: +420 532 123 392
<http://www.tungaloy.co.jp/cz/>

Tungaloy Ibérica S.L.

Phone: +34 93 1131360 Fax: +34 93 1131361
<http://www.tungaloy.co.jp/es/>

Tungaloy Scandinavia AB

Phone: +46-4621 19200 Fax: +46-4621 19207
<http://www.tungaloy.co.jp/se/>

LLC Tungaloy Rus

Phone: +7 4722 33 97 23 Fax: +7 4722 33 97 23
<http://www.tungaloy.co.jp/ru/>

Tungaloy Polska Sp. z o.o

Phone: +48-22-617-0890 Fax: +48-22-617-0890
<http://www.tungaloy.co.jp/pl/>

Tungaloy Cutting Tool (Shanghai) Co.,Ltd.

Phone: +86-21-3632-1880 Fax: +86-21-3621-1918
<http://www.tungaloy.co.jp/tcts/>

Tungaloy Cutting Tool (Thailand) Co.,Ltd.

Phone: +66-2-714-3130 Fax: +66-2-714-3134
<http://www.tungaloy.co.th/>

Tungaloy Singapore(Pte.),Ltd.

Phone: +65-6391-1833 Fax: +65-6299-4557
<http://www.tungaloy.co.jp/tspl/>

Tungaloy India Pvt. Ltd.

Phone: +91-22-6124-8804 Fax: +91-22-6124-8899
<http://www.tungaloy.co.jp/in/>

Tungaloy Korea Co., Ltd

Phone: +82-2-6393-8930 Fax: +82-2-6393-8952
<http://www.tungaloy.co.jp/kr/>

Tungaloy Malaysia Sdn Bhd

Phone: +603-7805-3222 Fax: +603-7804-8563
<http://www.tungaloy.co.jp/my/>

Distributed by:



ISO 9001 certified
QC00J0056
Tungaloy Corporation

18/10/1996

ISO 14001 certified
EC97J1123
Tungaloy Group
Japan site and Asian
production site
26/11/1997